

THE RIGHT CHOICE FOR HEAVY-DUTY COMMERCIAL APPLICATIONS





CS® - Contract System

The Hotel Track - Hand draw track system for hotels or any other heavy-duty use. Aluminum extrusion, powder coated and lubricated for wall or ceiling mount. Can be used with wood pole fascia or metal flat fascia. Available in -25 white, -59 black, -65 brown, and -90 silver.

51012-25	white	12' x 20 tracks/bundle = 240'	51016-59	black	16' x 20 tracks/bundle = 320'
51014-25	white	14' x 20 tracks/bundle = 280'	51020-59	black	20' x 20 tracks/bundle = 400'
51016-25	white	16' x 20 tracks/bundle = 320'	51016-65	brown	16' x 20 tracks/bundle = 320'
51020-25	white	20' x 20 tracks/bundle = 400'	51016-90	silver	16' x 20 tracks/bundle = 320'



ASSEMBLED SETS Include track, carriers, masters, brackets and 36" fiberglass baton. Indicate pinch pleat, Ripplefold, accordiafold or cubicle.



CAN BE BENT AND CURVED

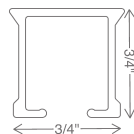

APPLICATION
Hand Draw
One or Two Way

PLEAT STYLE **STACKBACK**
Ripplefold 6" per width
Pinch Pleat 7" per width
Cubicle 5" per width
Accordiafold 5" per width

MOUNTING
Wall
Ceiling
Can be spliced

MAX WEIGHT
6 lbs/ft
Depending on application

CS Carriers



2107-25 60% fullness, 2 5/8" OC
2106-25 80% fullness, 2 3/8" OC
2105-25 100% fullness, 2 1/8" OC
2108-25 120% fullness, 1 7/8" OC
-59 Black
Wheeled Connected Snap Carrier in plastic sleeve roll of 500

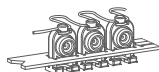

NEW!

2207-25 60% fullness, 2 5/8" OC
2206-25 80% fullness, 2 3/8" OC
80% Only -59 Black, -65 Brown, -90 Silver
2205-25 100% fullness, 2 1/8" OC
2208-25 120% fullness, 1 7/8" OC
Wheeled Connected Snap Carrier on plastic strip box of 500

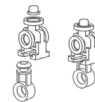

2006-25
Wheeled Snap Carrier for accordiafold box of 500
2007-25
Pendant for carrier box of 500



2006-25
-59 Black
Snap Carrier for accordiafold box of 500



52002-25
-59 Black, -65 Brown
Slim Line Ball Bearing Carrier box of 1000



52008-25
-59 Blk, -65 Brn +10%
Slim Line Klick Carrier draperies hang to conceal track box of 250



52108-25
-59 Black
Stop Carrier prevents slide back box of 100



52003-25
-65 Brown
Economy Slide box of 2000



52100-25
Ball Bearing Carrier w/ Stainless Hook slim line - use w/ grommets box of 1000



52106-25
Contract Klick Carrier w/ Stainless Hook use with grommets box of 100



9001-25
J Hook, 1 1/8" use with **52106-XX** box of 1,000



52005-25
Button Slide Carrier box of 1000



52105-25
Button Slide Carrier w/ Hook box of 500



2202-25
Button Slide Carrier w/ Breakaway Carrier bag of 5000

CS Masters

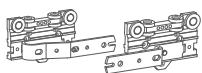

52502-25 Overlap R
52504-25 Underlap L
-59 Black
Standard Multi-Functional Master Use stiffener w/ exposed baton or hooks w/ hidden baton box of 100

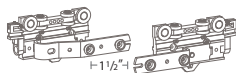

52502-25A Overlap R
52504-25A Underlap L
-59A Black
Standard Multi-Functional Master w/ snaps and baton adaptor box of 100

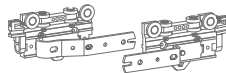

52502-25B Overlap R
52504-25B Underlap L
Standard Multi-Functional w/ baton adaptor for stiffener box of 50

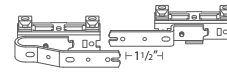

52508-25 Overlap R
52509-25 Underlap L
-59 Black, -65 Brown
Swivel Foot Multi-Functional Master Use with bends and curves box of 100

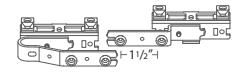

52508-25A Overlap R
52509-25A Underlap L
-59 Black, -65 Brown
Swivel Foot Multi-Functional Master w/ snaps box of 100

CS Masters Continued



52501-25 Overlap R
52503-25 Underlap L
Stiffener Master
box of 50



52401-25 Overlap R
52403-25 Underlap L
Stiffener Master
w/ snaps and adaptor
box of 50

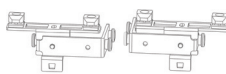

52410-25 Butt R
52409-25 Butt L
-59 Black
Standard Butt Master
w/ snaps and for baton use
box of 50

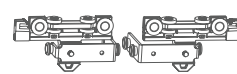

52411-25A Butt R
52412-25A Butt L
Wheeled Butt Master
w/snap adaptor
Designed for hidden baton
box of 50

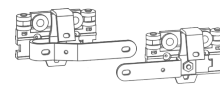

52514-25 Overhead R
52515-25 Underhead L
Over the Top Baton Master
Designed for exposed baton
box of 100

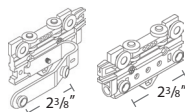

52601-25A Overlap R
52603-25A Underlap L
Extended Spacing Master
w/ snaps and adaptor
box of 100



B8809-23-00 Overlap R
B8809-24-00 Underlap L
-59 Black
Plastic Snap Master
box of 25



2552-25
6" Extension Arm for master
Use w/ two one-way draws
box of 50

CS Brackets



3001-25
-59 Black, -65 Brown, -90 Silver
Regular Duty Ceiling
box of 100



3002-25
Klick On Ceiling
with steel spring clip
for use with drop ceilings
box of 100



30031-25
-59 Black, -65 Brown, -90 Silver
NEW!
Ceiling Bracket Cover
use with 3003-25
box of 100



3901-25
-59 Black, -65 Brown, -90 Silver
Ceiling Splice/Bracket
box of 50

CS Other Components



52304-25
-59 Black, -65 Brown, -90 Silver
NEW!
End Cap - Short
box of 100



52305-25
-59 Black, -65 Brown, -90 Silver
NEW!
End Cap - Long
box of 100



52301-25
-59 Black, -65 Brown, -90 Silver
End Cap w/ Economy Slide
must add 2004-25 for Ripplefold
box of 400



52302-25 Right Return
52303-25 Left Return
End Cap w/ Return Plate, Snap
for pinch pleat or Ripplefold
box of 100



3003-25
-59 Black, -65 Brown, -90 Silver
Heavy Duty Ceiling
w/ Smart Klick
box of 100



30031-25
-59 Black, -65 Brown, -90 Silver
NEW!
Ceiling Bracket Cover
use with 3003-25
box of 100

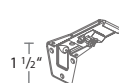

53202-25
-59 Black, -65 Brown, -90 Silver
3" Smart Klick Wall Bracket
w/ wide base, adjusts 3-4.5"
box of 100

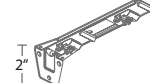

53206-25
-59 Black, -65 Brown, -90 Silver
6" Smart Klick Double Wall
Bracket w/ wide base
adjusts 2.5"-4" & 6"-7.5"
box of 50

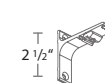

3280-25
-59 Black, -65 Brown, -90 Silver
3" Wall Bracket for
Wood Poles, heavy duty
projection 2 1/2"
box of 20



2305-25
-59 Black, -65 Brown, -90 Silver
Twist On End Stop
box of 100



52307-90
End Lock
box of 100

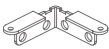

2308-25
Return Plate
reversible, 2 1/2" return
box of 100



2551-25
Small Extension Arm
box of 50

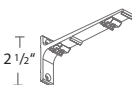

3281-25
-59 Black, -65 Brown
6" Double Wall Bracket
for Wood Poles heavy duty
projection 1 1/2", 5 1/2"
box of 15

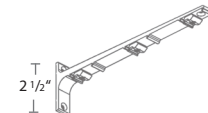

3284-25
-65 Brown, -90 Silver
10" Triple Wall Bracket
for Wood Poles, heavy duty
projection 2", 6 5/8", 9 5/16"
box of 10



32801-25
-59 Black, -65 Brown, -90 Silver
NEW!
Wall Bracket Cover
use with 3280, 3281
& 3284
box of 50



3903-25
-59 Black, -65 Brown, -90 Silver
Track Connector and key
3904-00
box of 10



54110-25
36" Fiberglass Baton w/ snap
box of 100
See all batons p. 25



3006-25
Suspension Bracket Tube
& Top
39" extension
10/box



3009-25
Suspension Bracket
Klick System Clip
box of 50



For use in

Hotels - motels - offices - schools - healthcare residential or at any location where a heavy duty hand drawn system is required

Applications

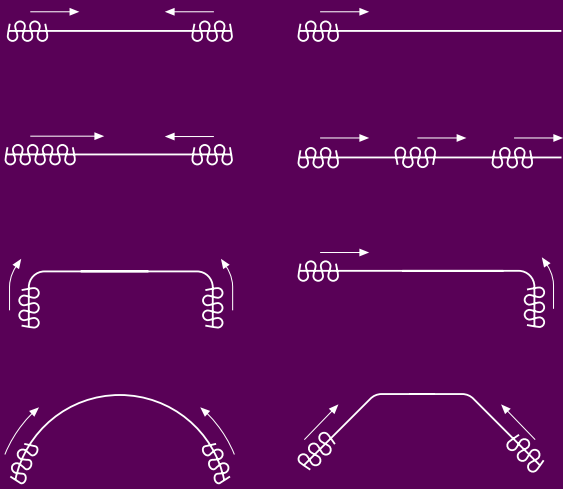

Features

- Stiffner is sewn onto drapery overlap
- Stiffner socket is placed into master arm
- Baton is attached by a screw through the eyelet and into the master arm.

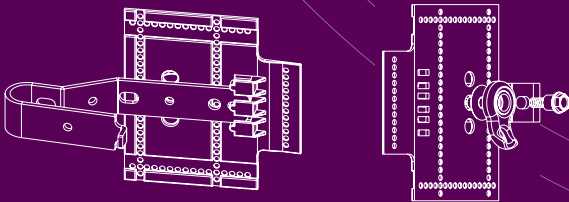

Custom bending & curving

The track can be curved and reversed curved using a 6" or 8" radius.

Actual size template is required.

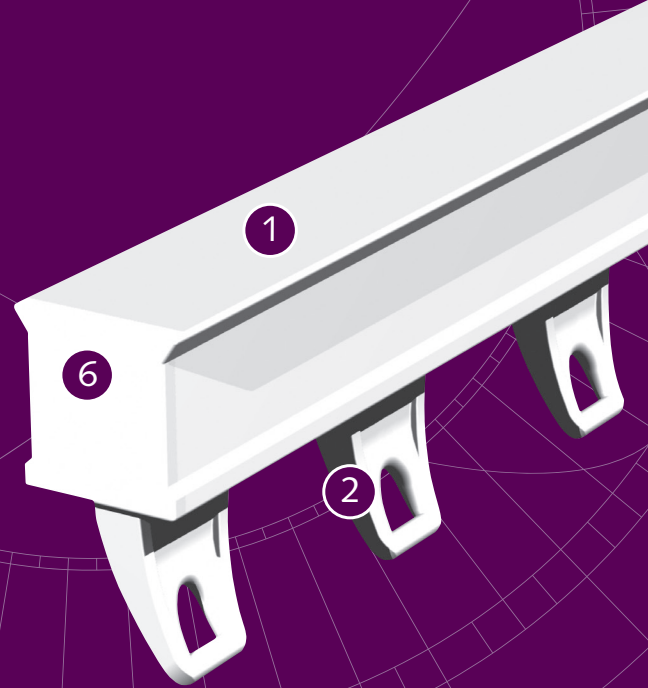
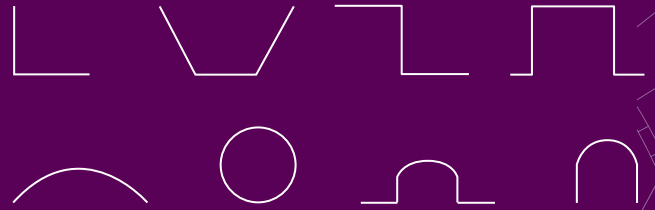

- ① CS Track
- ② Carrier
- ③ Master Carrier R/L Overlap
- ④ Master Carrier R/L Underlap
- ⑤ Carrier
- ⑥ Endcap with screw



Easy Installation
click - position - tighten

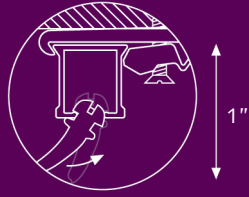

Clickable Carrier

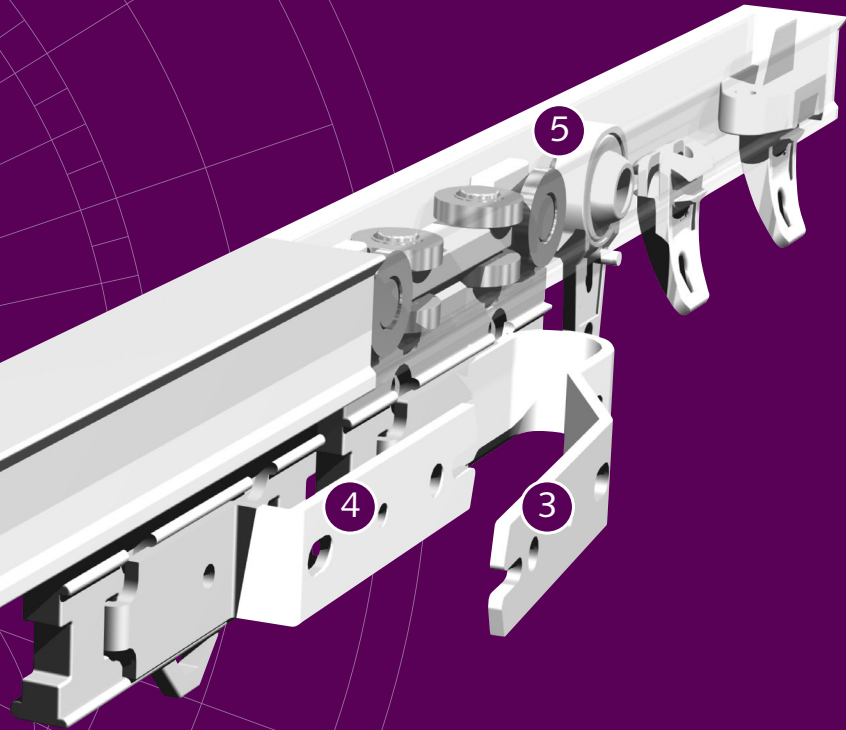

Mounting brackets

Brackets need to be placed every 24"

Smart Klick Ceiling Bracket

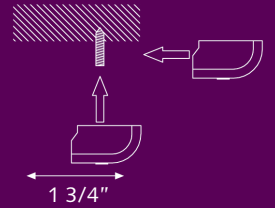

3" Wall Bracket for Wood Poles

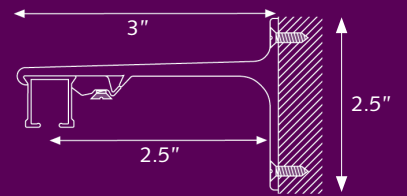

6" Double Wall Bracket for Wood Poles

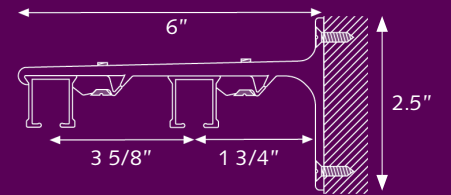

3" Wall Bracket with Wide Base
adjusts 3" - 4 1/2"

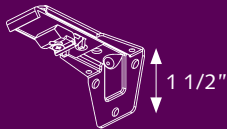

6" Double Wall Bracket with Wide Base
adjusts 2 1/2" - 4" and 6" - 7 1/2"

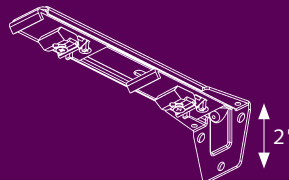

10" Triple Wall Bracket for Wood Poles

