



MANUAL
OPERATION



EASY
TO BEND

FOREST KS® Track

KS® Klick System Track with "Smart Klick" brackets easy install brackets

FOREST KS® Klick System Track
FOREST Batons

THE WORLD
BEHIND
YOUR
DRAPERIES

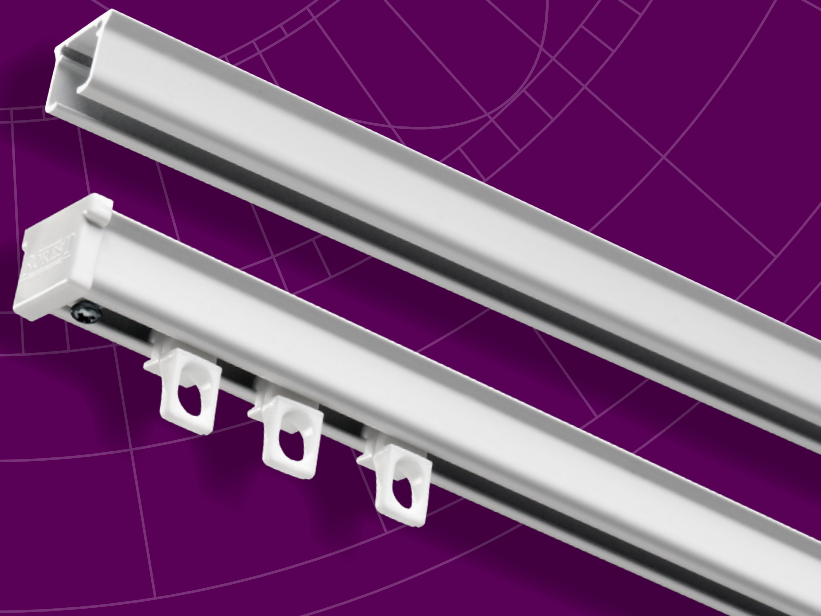

FOREST KS®



Scan for more information on the FOREST Track Systems



25
White

59
Black

65
Brown

90
Grey

KS® KLICK SYSTEM

- Aluminum extrusion, powder coated and lubricated with a patented process.
- Maximum weight is 3 lbs/ft.
- Bendable – KS trackscan be bent and curved. An exact size template is required.
- Hand or baton draw, one or two way.
- Stackback: ripplefold - 6" per width, pinchpleat - 7" per width, cubicle - 5" per width, accordiafold - 5" per width.

ASSEMBLED SYSTEM

Includes track, masters, pinchpleat or ripplefold carriers, brackets, and 36" white fiberglass baton

BATON OPTIONS



White fiberglass batons are available in 36", 48", 60", and 72" lengths. See all baton options, including the finishes below, at the end of brochure.



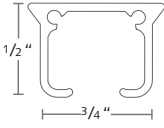
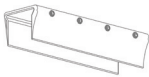

25
White

59
Black















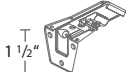
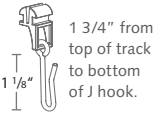
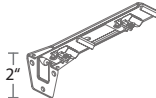

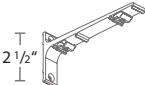
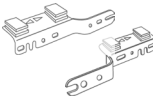

81
Bronze

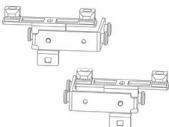
90
Grey

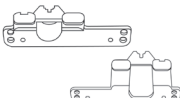
KS	COMPONENT
•	 <p>KS Klick System Track 1013-25 white 13' 1" 1016-25 white 16' 4" 1019-25 white 19' 8" 1016-59 black 16' 4" 1016-65 brown 16' 4" 1016-90 grey 16' 4"</p>
•	 <p>3905-25 59 black, 65 brown, 90 grey Track Connector, key 3904-00</p>
•	 <p>2309-25 59 black, 65 brown, 90 grey KS End Cap Multifunctional</p>

KS	COMPONENT
•	 <p>2309-25S 59S black, 90S grey KS End Cap Short reduces light gap</p>
•	 <p>9100-00 Channel Protector</p>
•	 <p>3001-25 59 black, 65 brown, 90 grey Regular Duty Ceiling Bracket</p>
•	 <p>3901-25 59 black, 65 brown, 90 grey Ceiling Splice/ Bracket</p>

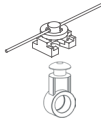
FOREST KS®

KS	COMPONENT	KS	COMPONENT
●	 <p>3003-25 59 black, 65 brown, 90 grey Heavy Duty Ceiling Bracket w/ Smart Klick</p>	●	 <p>52003-25 65 brown Economy Slide</p>
●	 <p>30031-25 59 black, 65 brown, 90 grey Ceiling Bracket Cover use with 3003-XX</p>	●	 <p>52004-25 Low Profile Ball Bearing Carrier</p>
●	 <p>53202-25 59 black, 65 brown, 90 grey 3" Smart Klick Wall Bracket w/ wide base, adjusts 3-4.5"</p>	●	 <p>2201-25 59 black , 65 brown Klick Carrier w/ Stainless Hook Use with grommets 1 3/4" from top of track to bottom of J hook. 1 1/8"</p>
●	 <p>53206-25 59 black, 65 brown, 90 grey 6" Smart Klick Double Wall Bracket w/ wide base adjusts 2.5"-4" & 6"-7.5"</p>	●	 <p>52005-25 Button Slide Carrier</p>
●	 <p>3280-25 59 black, 65 brown, 90 grey 3" Wall Bracket, heavy duty projection 2 1/2"</p>	●	 <p>52105-25 Button Slide Carrier w/ Hook</p>
●	 <p>3281-25 59 black, 65 brown, 90 grey 6" Double Wall Bracket, heavy duty projection 1 1/2", 5 1/2"</p>	●	 <p>2525-25 Overlap R 2526-25 Underlap L 59 black , 65 brown Pinchpleat Master 2527-25 Overlap L 2528-25 Underlap R</p>
●	 <p>32801-25 59 black, 90 grey Wall Bracket Cover use with 3280 & 3281</p>	●	 <p>52410-25 Butt R 52409-25 Butt L 59 black Standard Butt Master w/ snaps and for baton use</p>
●	 <p>2001-25 59 black, 65 brown, 90 grey Klick Carrier, for pinch pleat</p>	●	 <p>B8809-23-00 Overlap R B8809-24-00 Underlap L 59 black Plastic Snap Master</p>
●	 <p>2002-25 59 black, 65 brown, 90 grey Shirrtape Carrier</p>	●	 <p>2305-25 59 black , 65 brown, 90 grey Twist On End Stop</p>
●	 <p>2004-25 59 black Snap Carrier, for accordiafold</p>	●	 <p>52307-90 End Lock</p>
●	<p>Two Piece Connected Snap Carrier w/ Square Base, in plastic sleeve. Use 1 1/4" snap tape</p> <p>2114-25, 59 black 60% fullness, 2 5/8" OC 2111-25, 65 brown, 90 silver 80% fullness, 2 3/8" OC 2112-25, 59 black 100% fullness, 2 1/8" OC 2115-25, 59 black 120% fullness, 1 7/8" OC</p> 	●	 <p>2308-25 Return Plate reversible, 2 1/2" return</p>
		●	 <p>54110-25 36" Fiberglass Baton w/ snap See all batons at the end of brochure</p>

● Standard item in assembled sets.

FOREST KS® SPECIFICATIONS



PRODUCT INFORMATION

- Highly efficient hand drawn system for all types of light to medium weight draperies.
- Quick installation with “Smart Klick” brackets for wall and ceiling applications plus optional cover caps that conceal the screws.
- Bendable - KS can be curved and reversed curved using a 4” radius or continuous curve.
- Suitable for special window shapes such as circular, arched and triangular.
- Heavy duty clickable carriers are UV-protected and offer smooth, easy traversing. Shape is offset so pleats hang straight.
- Can also be used with ripplefold and accordiafold drapery.
- Maximum fabric weight: 3 lbs per foot.
- Finish colors available: white, black, brown, and silver.
- Available lengths: 13’1” , 16’4” , and 19’8” .
- Track finish: chromated powder coating with a factory applied patented dry lubricant.

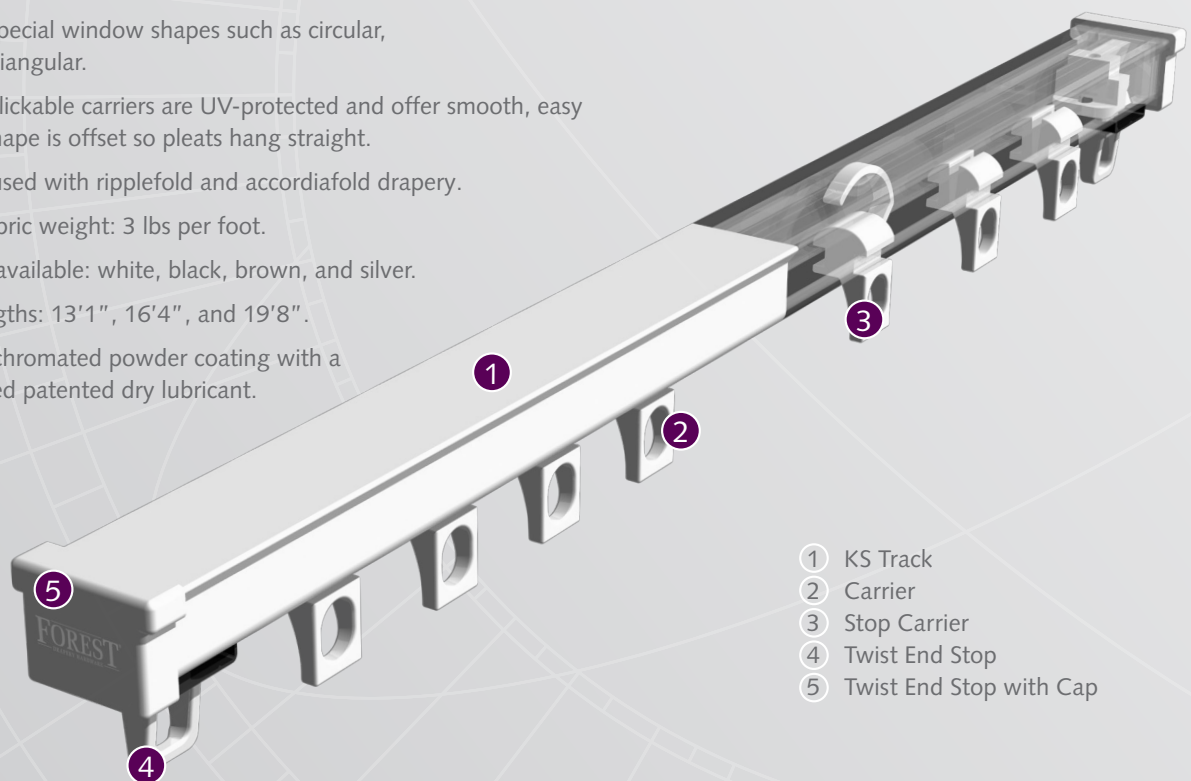



PROFILE

- Weight: 1.62 ounce per ft.
- Aluminum Extrusion
- Dimensions: 3/4" x 1/2"

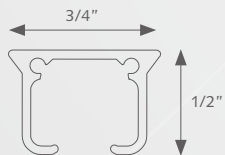

FOR USE IN

Hotels, offices, schools, healthcare, residences, boats, campers, planes or at any location where an efficient hand drawn system is required.

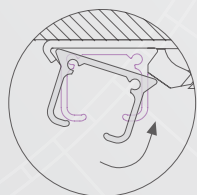

Easy installation
click - position - tighten

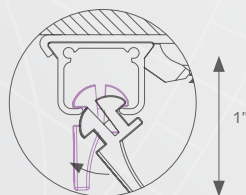

clickable carrier

BENDING / CURVING

The track can be curved and reversed curved using a 6" or 8" radius. Continuous curving is also possible with the electrical bending tool. Actual size template is required.

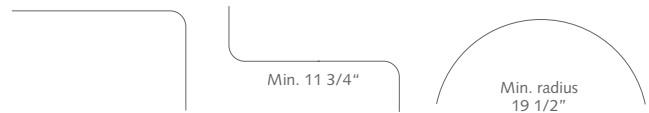

APPLICATIONS

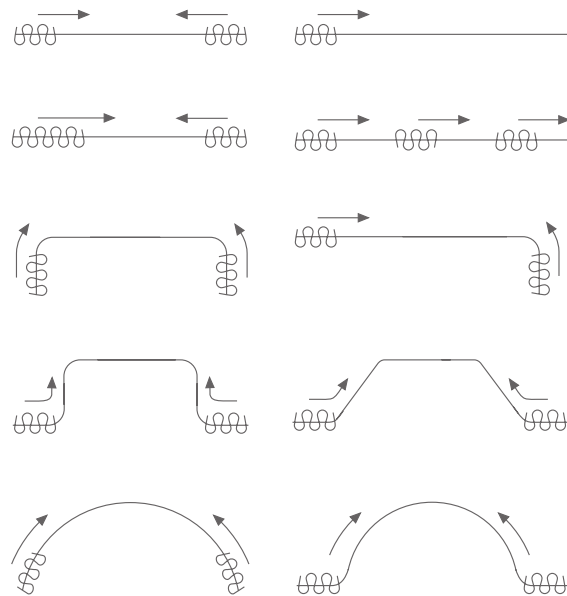

MOUNTING BRACKETS

Brackets need to be placed every 36".

Heavy Duty Ceiling Bracket with Smart Klick 3003-XX

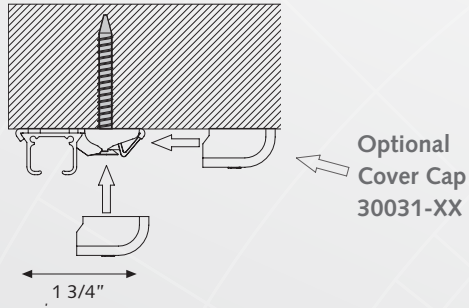

3" Smart Klick Wall Bracket 53202-XX

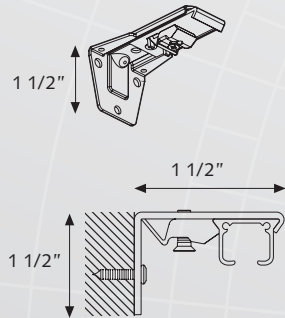

6" Smart Klick Double Wall Bracket 53206-XX

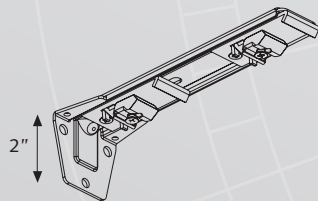

3" Single Wall Bracket 3280-XX

A) 3" B) 2 1/2"

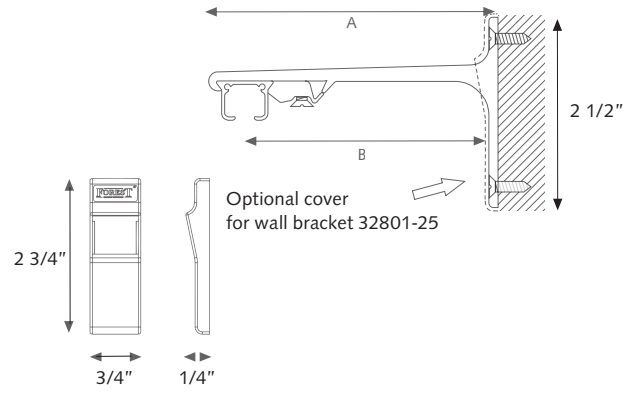





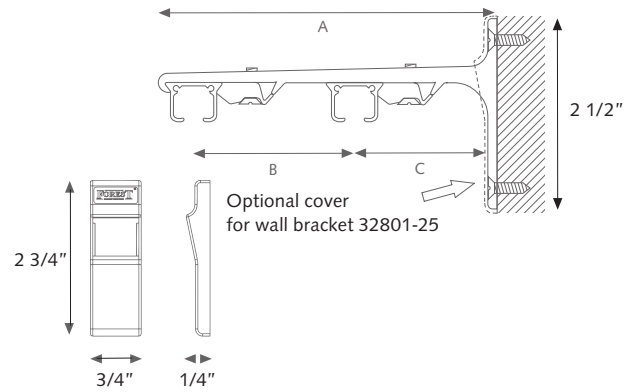







6" Double Wall Bracket 3281-XX

A) 6" B) 3 5/8" C) 1 3/4"









FOREST BATONS

FIBERGLASS, ACRYLIC, ADA & COMPONENTS

BATONS	COMPONENT	BATONS	COMPONENT
 	3/8" Fiberglass Baton Must order screw separately 36" 54110-25 white w/ snap 54310-25 white w/ adaptor 54110-59, 81, 90 w/ snap 48" 54111-25 white w/ snap 54311-25 white w/ adaptor 54111-59, 81, 90 w/ snap 60" 54112-25 white w/ snap 54312-25 white w/ adaptor 54112-59, 81, 90 w/ snap 72" 54113-25 white w/ snap 54313-25 white w/ adaptor 54113-59, 81, 90 w/ snap 84" 54114-25 white w/ snap 96" 54115-25 white w/ snap	 	1/2" Clear Acrylic Baton Must order screw separately 36" 54510-00 w/ snap 54710-00 w/ adaptor 48" 54511-00 w/ snap 54711-00 w/ adaptor 60" 54512-00 w/ snap 54712-00 w/ adaptor 72" 54513-00 w/ snap 54713-00 w/ adaptor
	Colors available for 3/8" Fiberglass Batons  25 White  59 Black  81 Bronze  90 Grey		ADA Clear Acrylic Baton  48" 54911-00 w/ adaptor
			 9013-00 Baton Holder, clear acrylic
			 54001-16 Baton Snap
			 9015-00 Hex Head Shoulder Screw for baton w/ adaptor
			 54000-16 D-Ring

DECORATIVE METAL & WOOD

 29MWAND-XX 40" Metal Baton	 29AWAND-16 40" Round Metal Baton Stainless Steel	 29SWAND-16 40" Square Metal Baton Stainless Steel	 29IWAND-XX 40" Wrought Iron Baton	 19WWAND-XX 40" Wood Baton	 19CWAND-XX 40" Modern Baton
--	--	---	--	--	--