



CORD
CONTROL

FOREST CCS Track

CCS Cord Control System Track



THE WORLD
BEHIND
YOUR
DRAPERIES



Scan for more information on the FOREST CCS Contract Cord System

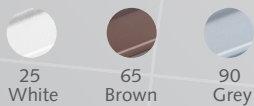

CCS® CONTRACT CORD SYSTEM











- Aluminum extrusion, powder coated and lubricated with a patented process.
- Maximum weight is 50 lbs per system.
- Bendable – CCS Track can be bent and curved. An exact size template is required.
- Cord draw, one or two way. Bead chain also available.
- Stackback: Ripplefold - 6" per width, pinchpleat - 7" per width, accordiafold - 5" per width.
- All Forest corded products include a child safety tension device and warning label.

ASSEMBLED SYSTEM

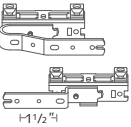
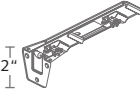
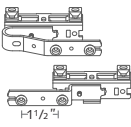
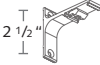
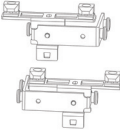
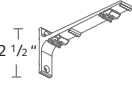
Includes track, masters, pinchpleat or ripplefold carriers, brackets, cord, tension pulley, child safety device.

CCS	COMPONENT
•	 <p>CCS Contract Cord Track 20 tracks/bundle 51116-25 white 16' 51116-65 brown 16' 51116-90 grey 16'</p>
•	 <p>3906-25 59 black, 65 brown, 90 grey Track Connector</p>
•	 <p>52801-25 65 brown, 90 grey End Pulley, 2 1/4" Reversible Use on right or left</p>

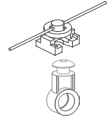
CCS	COMPONENT
•	 <p>52801-25A Right 52801-25B Left End Pulley w/ Snap 2 1/4 Reversible, for Ripplefold</p>
•	 <p>52803-25 65 brown, 90 grey Small End Pulley 1 1/2" Reversible, use with Butt Masters and one-way draw</p>
•	 <p>3001-25 59 black, 65 brown, 90 grey Regular Duty Ceiling Bracket</p>

CCS	COMPONENT	CCS	COMPONENT
●	 <p>3003-25 59 black, 65 brown, 90 grey Heavy Duty Ceiling Bracket w/ Smart Klick</p>	●	 <p>52008-25 59 black, 65 brown Slim Line Klick Carrier draperies hang to conceal track</p>
●	 <p>30031-25 59 black, 65 brown, 90 grey Ceiling Bracket Cover use with 3003-XX</p>	●	 <p>52004-25 Low Profile Ball Bearing</p>
●	 <p>53202-25 59 black, 65 brown, 90 grey 3" Smart Klick Wall Bracket w/ wide base, adjusts 3-4.5"</p>	●	 <p>52508-25 Overlap R 52509-25 Underlap L 59 black, 65 brown Swivel Foot Multi-Functional Master for bends and curves</p>
●	 <p>53206-25 59 black, 65 brown, 90 grey 6" Smart Klick Double Wall Bracket w/ wide base adjusts 2.5"-4" & 6"-7.5"</p>	●	 <p>52508-25A Overlap R 52509-25A Underlap L 59 black, 65 brown Swivel Foot Multi-Functional Master w/ snaps</p>
●	 <p>3280-25 59 black, 65 brown, 90 grey 3" Wall Bracket, heavy duty projection 2 1/2"</p>	●	 <p>52410-25 Butt R 52409-25 Butt L 59 black Standard Butt Master w/ snaps for baton use</p>
●	 <p>3281-25 59 black, 65 brown, 90 grey 6" Double Wall Bracket, heavy duty projection 1 1/2", 5 1/2"</p>	●	 <p>52510-25 59 black, 65 brown, 90 grey Cord Connector</p>
●	 <p>32801-25 59 black, 90 grey Wall Bracket Cover use with 3280 & 3281</p>	●	 <p>9004-25 3.2mm Cord 333.34 yds./roll</p>
●	 <p>Two Piece Connected Snap Carrier w/ Square Base, in plastic sleeve. Use 1 1/4" snap tape 2114-25, 59 black 60% fullness, 2 5/8" OC 2111-25, 59 black, 65 brown, 90 grey 80% fullness, 2 3/8" OC 2112-25, 59 black 100% fullness, 2 1/8" OC 2115-25, 59 black 120% fullness, 1 7/8" OC</p>	●	 <p>49501-00 Tension Device For child safety</p>

● Standard item in assembled sets.

FOREST CCS® SPECIFICATIONS



PRODUCT INFORMATION

- Heavy duty cord operated system, with separate internal cord channels; preventing cord sag and eliminating cord tangle.
- Quick installation with "Smart Klick". brackets for wall and ceiling applications.
- Bendable; it can be curved and reversed curved with a 8" radius or continuous curve.
- Heavy duty clickable carriers - 10 carriers on a breakaway strip - UV protected.
- Can also be used for Forest Easyfold and accordiafold drapery systems.
- Maximum fabric weight is 50 lbs. per system.
- Track finish: chromated powder coating with a factory applied patented dry lubricant.
- Warranty: 10 years.



Easy installation
click - position - tighten



Clickable carrier

PROFILE

- Shown actual size 1:1
- Aluminum Extrusion
- Weight: 3.22 ounce per ft
- Dimensions: 3/4" x 3/4"

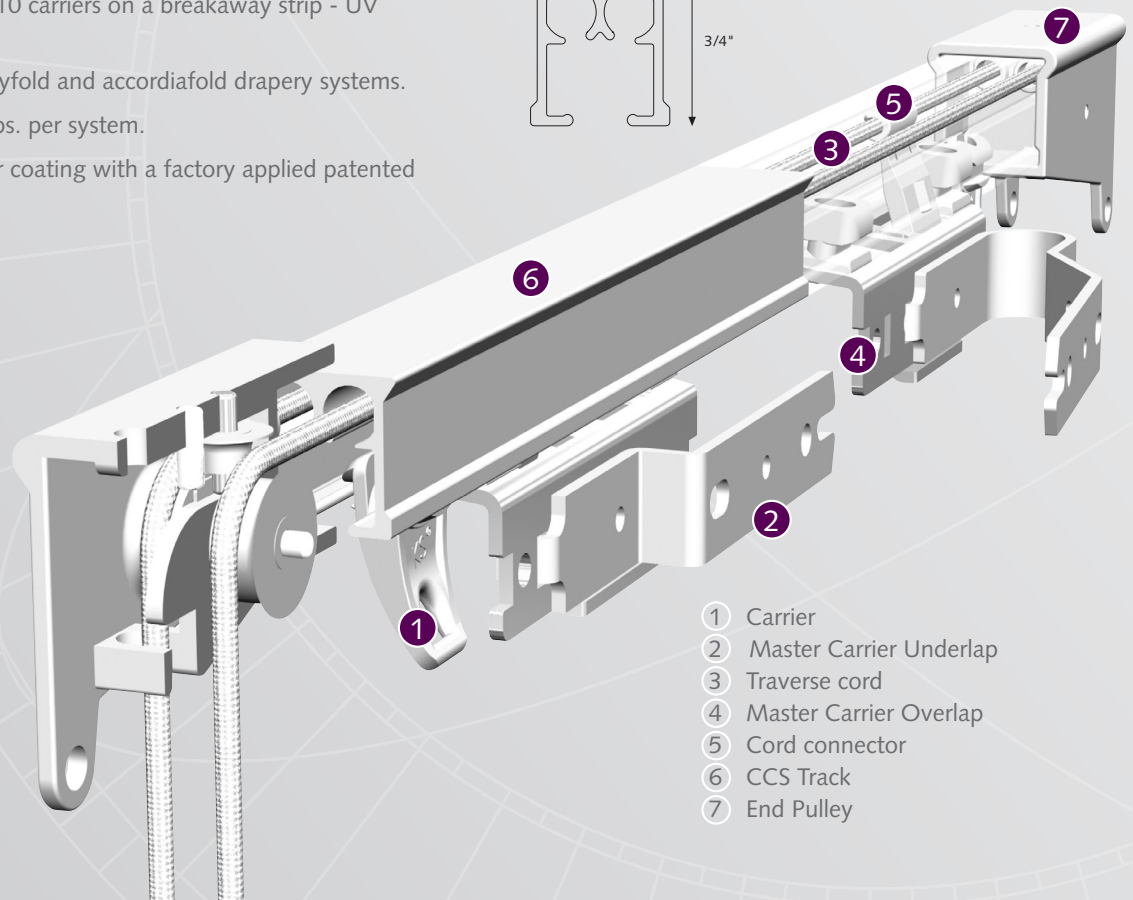
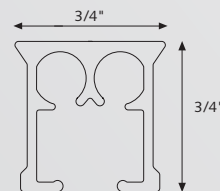



Smart Klick Ceiling Bracket with cover

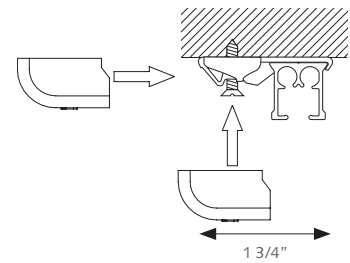

Smart Klick Single Wall Bracket

- A) 3" B) 2 1/2"
- A) 4" B) 3 1/2"

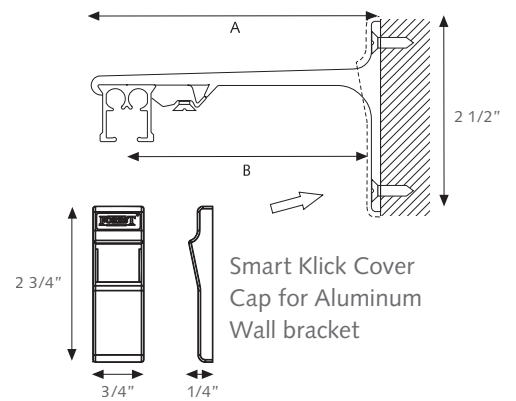

Smart Klick Wall Double Wall Bracket

- A) 6" B) 3 1/2" C) 1 3/4"
- A) 8" B) 3 1/2" C) 3 3/4"

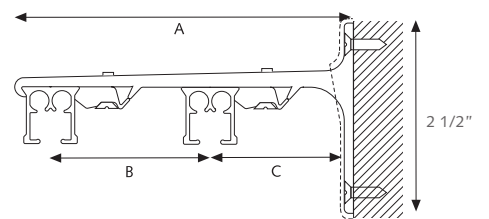

Smart Klick Triple Wall Bracket

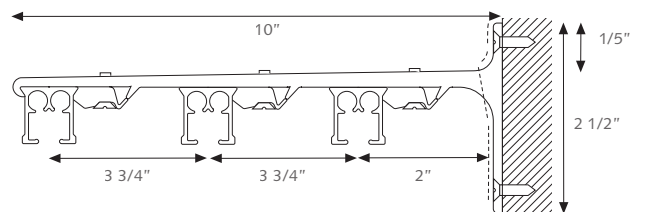

Brackets need to be placed every 36", depending on fabric weight.

APPLICATIONS

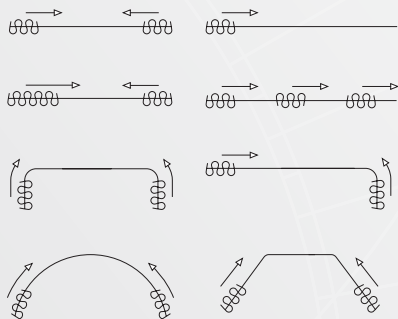

BENDING / CURVING

The track can be curved and reversed curved using an 8" radius. Continuous curving can be done with the electric powered bender.



FOR USE IN

Hotels - motels - offices - healthcare - schools - residential or any location where a cord operated system is required.