



**CHAIN
CONTROL**

FOREST RBS XL Roman Blind System

A larger profile of the original RBS Roman Blind System



THE WORLD
BEHIND
YOUR
DRAPERIES

FOREST RBS® XL



Scan for more information on the
FOREST RBS XL Roman Blind System

RBS ROMAN BLIND SYSTEM

The Forest Roman Blind System XL - RBS® XL was developed for taller windows and heavier fabrics. This roman blind system can pull up to 24 lbs of fabric. It comes with integrated Velcro tape so fabric can be easily attached and removed.

PRODUCT INFORMATION

- Cord drawn blind system.
- For all types of medium and heavy weight draperies.
- Elegant shaped aluminum profile with Velcro hook tape.
- Profile is aluminum with a chromated powder coated white finish.
- Maximum weight:
1:4 gear up to 24 lbs.
- Includes a 10 year warranty.
- Include child safety device and warning label.

CHILD SAFETY

All Forest corded products include a child safety tension device and a warning label.

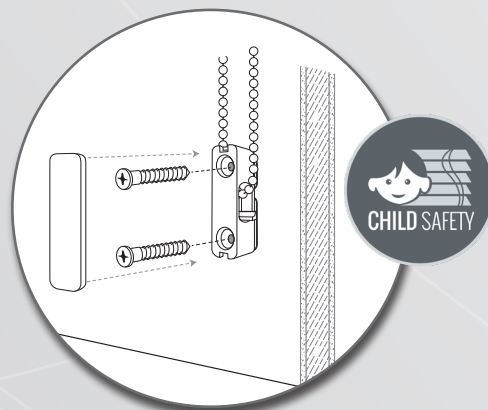

FOREST RBS® XL



PROFILE

- Aluminum extrusion 6063 T5
- Size 2" x 2 1/4"
- Color available: white

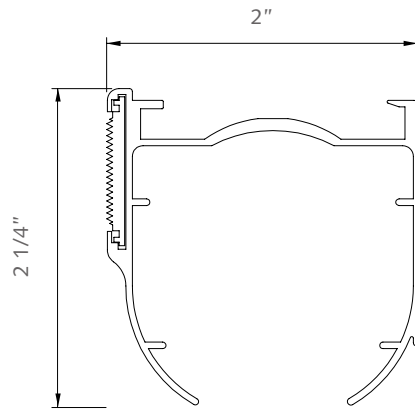





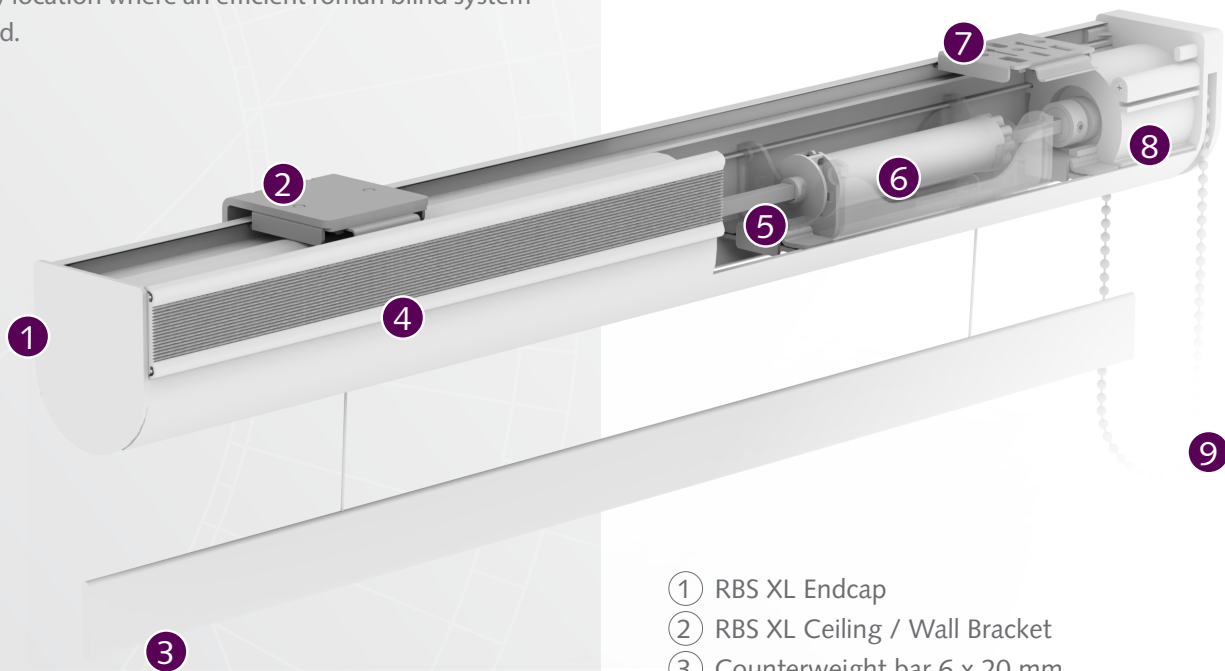





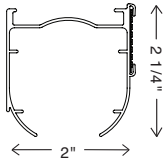

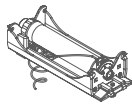

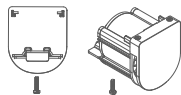

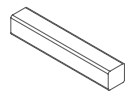
FOR USE IN

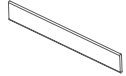
Hotels, offices, residences, schools, healthcare facilities, or at any location where an efficient roman blind system is desired.

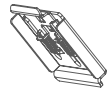

- ① RBS XL Endcap
- ② RBS XL Ceiling / Wall Bracket
- ③ Counterweight bar 6 x 20 mm.
- ④ RBS XL Track incl. Velcro Hook Tape
- ⑤ RBS Rod 3/16" X 3/16"
- ⑥ RBS XL Cord Drum
- ⑦ RBS XL Hidden Ceiling Bracket
- ⑧ RBS XL Control Unit 1:4
- ⑨ Chain

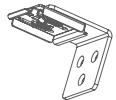
FOREST RBS® XL

RBS XL	COMPONENT	RBS XL	COMPONENT
•	 <p>44019-25 RBS XL Headrail with integrated Velcro tape 19' x 10 rails/bundle bundle = 190'</p>	•	 <p>39007-25 Velcro Tape 27 yds. per roll</p>
•	 <p>44003-25 RBS XL Cord Roll Support</p>	•	 <p>49006-25 Fiberglass Spines, 19' 3/16" diameter</p>
•	 <p>44311-25 RBS XL Control Unit w/ End Cap & Screw 1:4 gear to 24 lbs.</p>	•	 <p>49014-25 Plastic Snap Ring</p>
•	 <p>41119-90 19' Rod aluminum 3/16" x 3/16"</p>	•	 <p>49013-25 Plastic Ring Cord Guide</p>
•	 <p>49005-25 Counterweight, 19' aluminum 1" x 1/8"</p>	•	 <p>Endless Chain 25 white plastic or 90 nickel 49020-25, 90, 29" 49021-25, 90, 39" 49022-25, 90, 49" 49023-25, 90, 59" 49024-25, 90, 69" 49025-25, 90, 79" 49026-25, 90, 89" 49027-25, 90, 99"</p>
•	 <p>31116-25 Velcro Profile w/Hook Tape, 13.1'</p>	•	 <p>76047-90 Metal Ball Chain Stopper</p>
•	 <p>44004-90 RBS XL Ceiling Bracket nickel plated</p>	•	 <p>79005-00 Clear Ball Chain Stopper</p>
•	 <p>44033-90 RBS XL Wall Bracket nickel plated</p>	•	 <p>49501-00 Tension Device For child safety</p>
•	 <p>49008-25 Shade Leveler</p>		

• Standard item in assembled sets.