



**MANUAL**  
OPERATION



**EASY**  
TO BEND

## FOREST DS<sup>®</sup> Track

DS<sup>®</sup> Design System Track with an elegant profile

FOREST DS<sup>®</sup> Design System Track  
FOREST Batons

THE WORLD  
BEHIND  
YOUR  
DRAPERIES





Scan for more information on the FOREST Track Systems

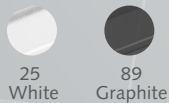

## DS® DESIGN SYSTEM

- Aluminum extrusion, powder coated and lubricated with a patented process.
- Maximum weight is 3 lbs/ft.
- DS tracks can be bent and curved. An exact size template is required.
- Hand or baton draw, one or two way.
- Stackback: ripplefold - 6" per width, pinchpleat - 7" per width, cubicle - 5" per width, accordiafold - 5" per width.



### ASSEMBLED SET

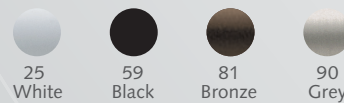

Includes track, masters, pinchpleat or ripplefold carriers, brackets, and 36" white fiberglass baton at the end of brochure.

### BATON OPTIONS

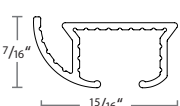
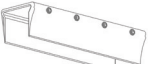













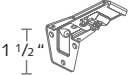

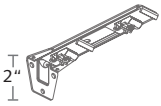
White fiberglass batons are available in 36", 48", 60", and 72" lengths. See all baton options, including the finishes below, at the end of brochure.

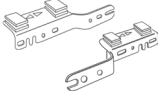

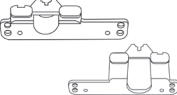
DS	COMPONENT
•	 <p>DS Design System Track  <b>1116-25</b> white  <b>1116-89</b> graphite                      16' 4"</p>
•	 <p><b>3905-25</b>  <b>59</b> black                      Track Connector                      + key <b>3904-00</b></p>
•	 <p><b>2309-25</b>  <b>59</b> blackKS End Cap Multifunctional</p>

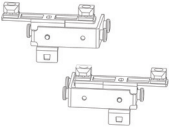
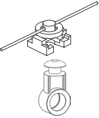
DS	COMPONENT
•	 <p><b>9100-00</b>                      Channel Protector</p>
•	 <p><b>3001-25</b>  <b>59</b> black                      Regular Duty Ceiling Bracket</p>
•	 <p><b>3901-25</b>  <b>59</b> black                      Ceiling Splice/Bracket</p>

# FOREST DS®

DS	COMPONENT	DS	COMPONENT
●	 <p><b>3003-25</b> 59 black Heavy Duty Ceiling Bracket w/ Smart Klick</p>	●	 <p><b>52003-25</b> 65 brown Economy Slide</p>
●	 <p><b>30031-25</b> 59 black Ceiling Bracket Cover use with 3003-XX</p>	●	 <p>1 3/4" from top of track to bottom of J hook. 1 1/8"</p> <p><b>2201-25</b> 59 black Klick Carrier w/ Stainless Hook Use with grommets</p>
●	 <p>1 1/2"</p> <p><b>53202-25</b> 59 black 3" Smart Klick Wall Bracket w/ wide base, adjusts 3-4.5"</p>	●	 <p><b>52005-25</b> Button Slide Carrier</p>
●	 <p>2"</p> <p><b>53206-25</b> 59 black 6" Smart Klick Double Wall Bracket w/ wide base adjusts 2.5"-4" &amp; 6"-7.5"</p>	●	 <p><b>52105-25</b> Button Slide Carrier w/ Hook</p>
●	 <p><b>2001-25</b> 59 black Klick Carrier, for pinch pleat</p>	●	 <p><b>2525-25</b> Overlap R <b>2526-25</b> Underlap L Pinchpleat Master <b>2527-25</b> Overlap L <b>2528-25</b> Underlap R</p>
●	 <p><b>2002-25</b> 59 black Shirrtape Carrier</p>	●	 <p><b>B8809-23-00</b> Overlap R <b>B8809-24-00</b> Underlap L 59 black Plastic Snap Master</p>
●	 <p><b>2004-25</b> 59 black Snap Carrier, for accordiafold</p>	●	 <p><b>52410-25</b> Butt R <b>52409-25</b> Butt L 59 black Standard Butt Master w/ snaps and for baton use</p>
●	 <p>Two Piece Connected Snap Carrier w/ Square Base, in plastic sleeve. Use 1 1/4" snap tape <b>2114-25</b>, 59 black 60% fullness, 2 5/8" OC <b>2111-25</b>, 65 brown, 90 grey 80% fullness, 2 3/8" OC <b>2112-25</b>, 59 black 100% fullness, 2 1/8" OC <b>2115-25</b>, 59 black 120% fullness, 1 7/8" OC</p>	●	 <p><b>2305-25</b> 59 black Twist On End Stop</p>
		●	 <p><b>52307-90</b> End Lock</p>
		●	 <p><b>2308-25</b> Return Plate reversible, 2 1/2" return</p>
		●	 <p><b>54110-25</b> 36" Fiberglass Baton w/ snap See all batons at the end of document</p>

● Standard item in assembled sets.

# FOREST DS® SPECIFICATIONS



## PRODUCT INFORMATION

- Elegant and aesthetically pleasing hand drawn system for all types of light to medium weight draperies.
- Quick installation with “Smart Klick” brackets for wall and ceiling applications.
- Hidden brackets are behind the elegant shape of the track.
- Heavy duty clickable carriers are UV protected and offer smooth, easy traversing.
- Can be used with pinchpleat, ripplefold and accordiafold draperies.
- Recommended maximum fabric weight is 3 lbs./ft.
- Track finish is a chromated powder coating with a factory applied patented dry lubricant.
- Limited lifetime warranty.

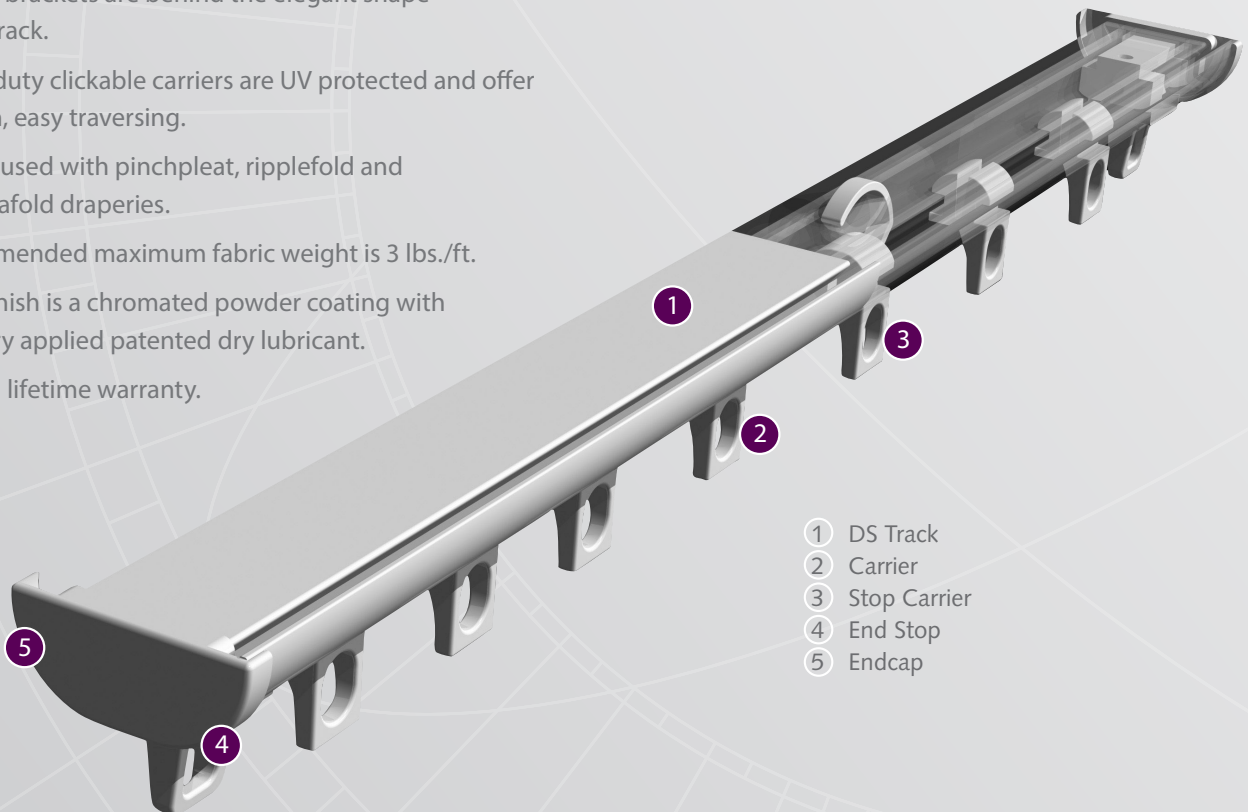

- ① DS Track
- ② Carrier
- ③ Stop Carrier
- ④ End Stop
- ⑤ Endcap



## PROFILE

- Aluminum Extrusion
- Dimensions: 1 1/4" x 1/2"



## FOR USE IN

Hotels, motels, offices, schools, healthcare facilities, residences or at any location where an elegant hand drawn system is desired.

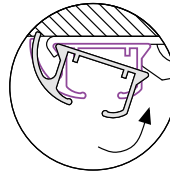

Easy installation  
click - position - tighten

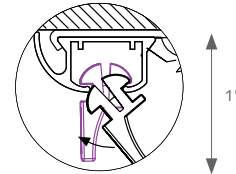

clickable carrier

## APPLICATIONS

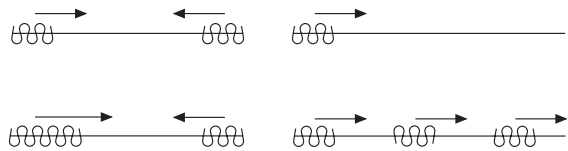

## MOUNTING BRACKETS

Brackets need to be placed every 24".

### Heavy Duty Ceiling Bracket with Smart Klick 3003-XX

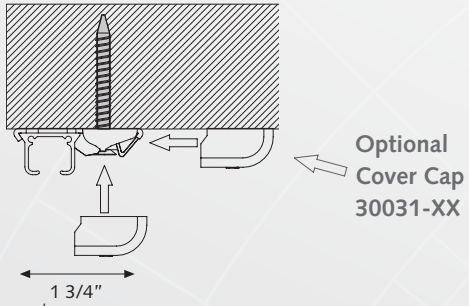

### 3" Smart Klick Wall Bracket 53202-XX

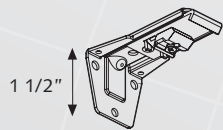



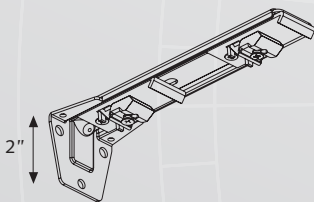









### 6" Smart Klick Double Wall Bracket 53206-XX



# FOREST BATONS

## FIBERGLASS, ACRYLIC, ADA & COMPONENTS

BATONS	COMPONENT
●	 snap  adaptor <b>3/8" Fiberglass Baton</b> Must order screw separately  <b>36"</b> 54110-25 white w/ snap 54310-25 white w/ adaptor  54110-59, 81, 90 w/ snap  <b>48"</b> 54111-25 white w/ snap 54311-25 white w/ adaptor  54111-59, 81, 90 w/ snap  <b>60"</b> 54112-25 white w/ snap 54312-25 white w/ adaptor  54112-59, 81, 90 w/ snap  <b>72"</b> 54113-25 white w/ snap 54313-25 white w/ adaptor  54113-59, 81, 90 w/ snap  <b>84"</b> 54114-25 white w/ snap  <b>96"</b> 54115-25 white w/ snap
	● Colors available for 3/8" Fiberglass Batons  25 White  59 Black  81 Bronze  90 Grey

BATONS	COMPONENT
●	 snap  adaptor <b>1/2" Clear Acrylic Baton</b> Must order screw separately  <b>36"</b> 54510-00 w/ snap 54710-00 w/ adaptor  <b>48"</b> 54511-00 w/ snap 54711-00 w/ adaptor  <b>60"</b> 54512-00 w/ snap 54712-00 w/ adaptor  <b>72"</b> 54513-00 w/ snap 54713-00 w/ adaptor
	●  adaptor <b>ADA Clear Acrylic Baton</b> <b>48"</b> 54911-00 w/ adaptor
●	 <b>9013-00</b> Baton Holder, clear acrylic
●	 <b>54001-16</b> Baton Snap
●	 <b>9015-00</b> Hex Head Shoulder Screw for baton w/ adaptor
●	 <b>54000-16</b> D-Ring

## BATONS DECORATIVE METAL & WOOD

